

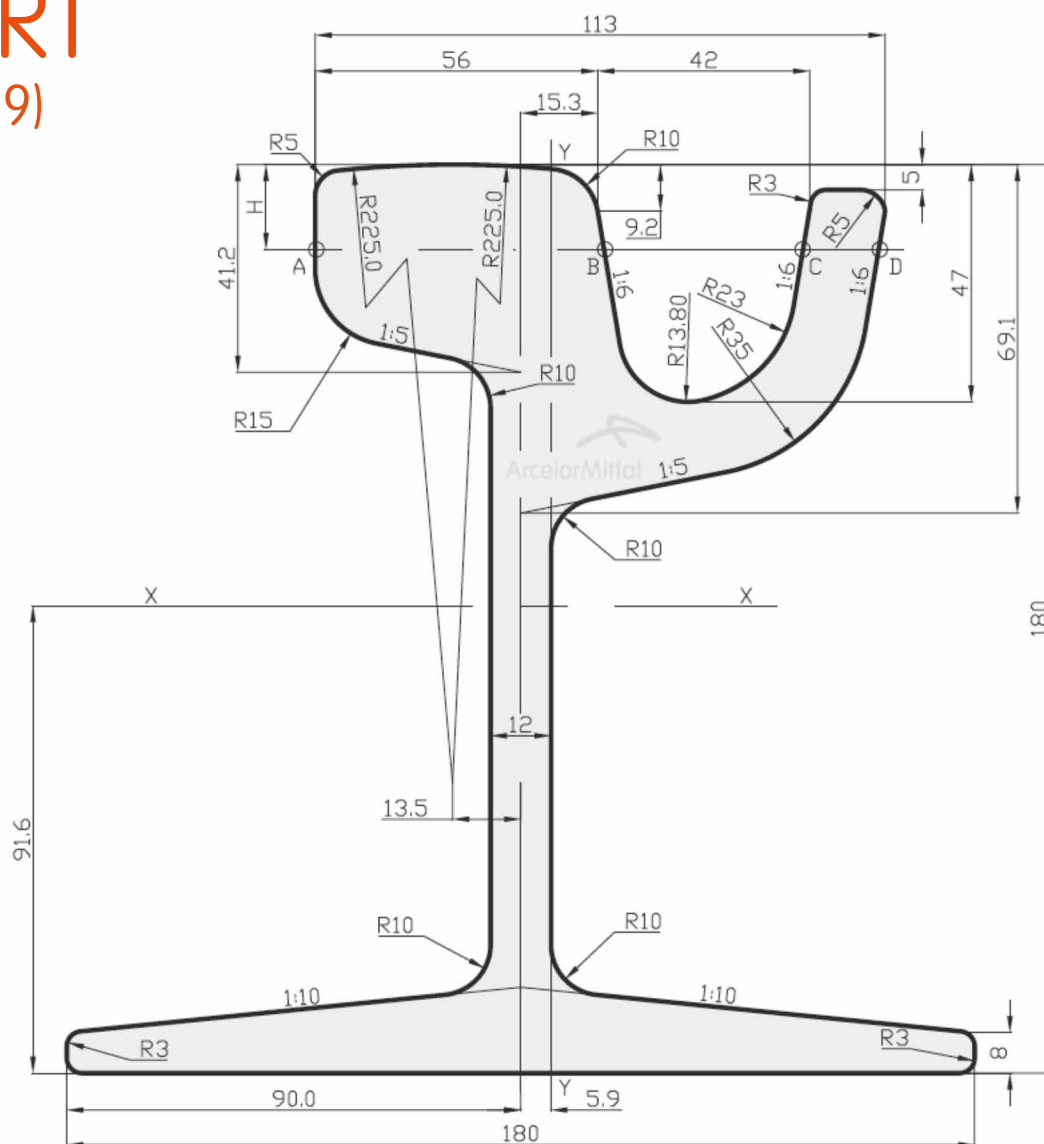

ArcelorMittal

Grooved Rails / Rillenschienen / Rail à Gorge

59R1 (Ri59)



ArcelorMittal

59R1 (Ri59)

Mass	58,97 kg/m
Area	75,12 cm ²
Moment of Inertia	
/xx	3266,8 cm ⁴
/xy	886,2 cm ⁴

Additional contact info: rails.specialsections@arcelormittal.com